

Xpelair XIDP in-line duct fans installation and operating instructions

Please leave this leaflet with the appliance for the benefit of the user.

Description

- These products are intended for connection to fixed wiring
 - Extract only or intake only, determined at installation (not reversible).
 - Can be installed with rigid or flexible ducting.
 - Designed for suspended or rigid mounting.
 - Suitable for continuous operation.
 - Single speed operation unless installed with XIC1 controller (available from Xpelair).
 - **Must be installed by a qualified electrician.**
 - **For fixed wiring circuits the protective fuse for the appliance must not exceed 5A.**
 - **WARNING: THESE APPLIANCES MUST BE EARTHED.**
 - **This appliance can be used by children aged 8 years and above and persons with reduced physical, sensory capabilities or lack of experience and knowledge if they have been given supervision or instruction concerning the use of the appliance in a safe way and understand the hazards involved. Children shall not play with the appliance.**
- Cleaning and maintenance of the appliance shall not be made by children.**

What you will need

- Suitable 3-core cable.
- A means for disconnection in all poles must be incorporated in the fixed wiring, in accordance with the wiring rules.
- An XIC1 speed controller, if required (available from Xpelair).
- Ducting long enough to connect from the position of the air intake to the position of the air outlet via the fan.
- Ducting accessories, including internal and external grilles and fasteners which are available from Xpelair.
- If using flexible ducting, you will need ducting of the same outside diameter as the lip of the fan and two metal solid duct fasteners to attach the ducting to each end of the fan.
- If suspending the fan, you will need strong enough support to suit your particular installation. For fan weights see table. Duct and ancillaries weights must be considered also.
- If installing in a position where condensation is likely to run backwards towards the fan, you will need a suitable condensation trap. The XCT100 is available from Xpelair for 100mm ducting only.

Where to locate it

Position of air intake

- As far away as possible from the main source of air replacement to ensure airflow across the room.
- Near the source of steam or fumes.
- Neither fan nor intake should be positioned where ambient temperatures are likely to exceed 50°C, or above a cooker hob or eye level grille.
- **If installing in a room containing a fuel burning device which has a non-balanced flue, it is the installer's responsibility to ensure there is enough replacement air to prevent fumes being drawn down the flue when the fan is operating up to maximum extract. For specific requirements, refer to Building Regulations.**
- **Exhaust air must not be discharged into a flue used for exhausting fumes from appliances supplied with energy other than electric. Requirements of all authorities concerned must be observed for exhaust air discharge.**
- When intended for use in possible chemical corrosive atmospheres, you must consult out Technical Sales Department. (For overseas markets, please contact your local Xpelair distributor).
- **This electrical product, in a shower room or bathroom, must be so situated that it cannot be touched by persons making use of the bath or shower.**
- **If the fan is intended to intake air, the inlet grille should be sited at least 0.5m away from the discharge outlet of a flued heating or cooking appliance.**

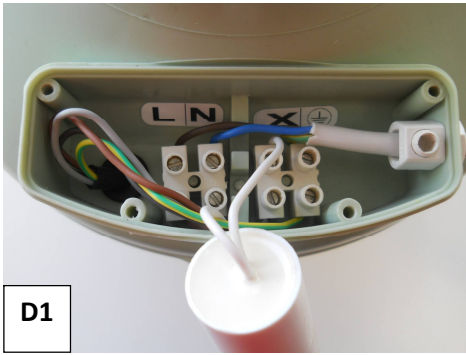

D1

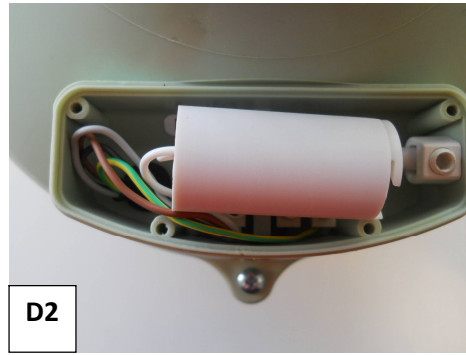

D2

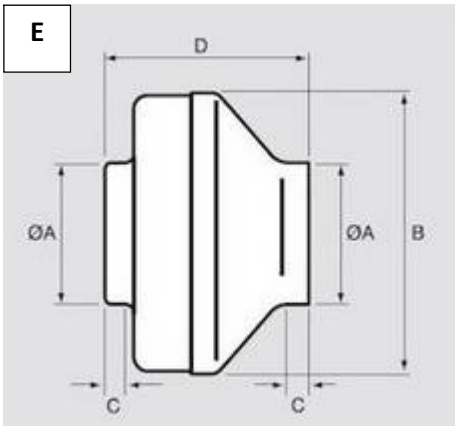

E

Do's and don'ts

- Do read all the instruction leaflet before commencing installation.
- Do install the controller with a double-pole isolating switch.
- Do make sure the mains supply is switched off before attempting to make electrical connections or carry out any maintenance or cleaning.

Guarantee

Customers outside UK – see international below.

- UK: The fan is guaranteed against defects for 2 years from the date of purchase.
- Please keep your purchase receipt.
- If you have any problems, contact Xpelair's Head Office at the address shown below.

Technical advice and service

Customers outside UK – see international below.

UK: Xpelair have a comprehensive range of services including:

- Free technical advice help-desk from Engineers on all aspects of ventilation
- Free design service, quotations and site surveys.
- Service and maintenance contracts to suit all requirements.

Please ask for details:

- By telephone on Techline: +44 (0) 844 372 7760
- By fax on Techfax: +44 (0) 844 372 7767
- At the address below

Head Office, UK Sales Office and Spares

Redring Xpelair Group Ltd, Newcombe House, Newcombe Way,
Orton Southgate, Peterborough, PE2 6SE, England
Telephone: +44 (0) 844 372 7761
Fax: +44 (0) 844 372 7762
Sales / Spares Hotline: +44 (0) 844 372 7750
Sales / Spares Faxline: +44 (0) 844 372 7760
<http://www.redringxpelair.com>

International

- Guarantee: Contact your local distributor or Xpelair direct for details.
 - Technical Advice and Service: Contact your local Xpelair distributor.
- International Sales Hotline: +44 (0) 1733 456789
International Sales Fax: +44 (0) 1733 456727



Redring Xpelair Group



R014

Part Number 24545AA
Revision A

Position of the fan

- The fan must be installed so that it is more than 2.3m above floor level.
- The fan can be fixed in different orientations to suit specific applications; intake, suspended, extract or standing. **A**
- The fan can be mounted to a suitably strong wall or roof member.

Position of air outlet

- At least 0.5m away from an open door or window, or the inlet of another ventilation device.

Installing the fan and isolating switch

1. Check that the electrical rating shown on the fan matches the mains supply.
 2. Isolate the mains supply.
 3. Lay in cable from the double pole isolating switch to the fan location (via the speed controller if fitted).
 4. Check that there are no buried pipes or cables (e.g. gas, water, electricity) behind the double pole isolating switch location.
 5. Lay in the cable from the double pole isolating switch to the electrical supply.
 6. Make the connections within the double pole isolating switch **B**.
- Warning: Do not make any connections to the electrical supply at this stage. All installations and wiring must conform to current I.E.E regulations (UK), local or appropriate regulations (other countries).

For Australia only:

These models are permanently connected to the mains supply and operation is controlled by a remote switch. They should be directly wired to the supply through an approved 10A wall mounted surface switch in accordance with the wiring rules. Children must be supervised to ensure that they do not play with the appliance.

Installing the ducting

1. Install ducting to connect the fan to the air intake and to the outlet. If the ducting is suspended, ensure that it is adequately supported.
2. Fit intake and outlet grilles as required.
3. If installing in a position where condensation is likely to run back towards the fan, install a condensation trap as near to the fan as possible.

Mounting the fan

1. Mount the fan, ensuring that the arrow marked on the side of the fan points towards the direction of airflow.
2. Screw the plastic mounting bracket to the wall in the desired position. Attach the metal bracket to the XIDP to suit the specific orientation **A** using two of the casing screws to hold the bracket in place. Slide the metal bracket into the plastic bracket to hold in place **B1**. Once the two brackets are placed together, there is a clip that holds the metal bracket in place. If the XIDP fan needs to be removed, just pull the clip on the underside of the plastic bracket and lift the fan from its mount **B2**.
3. Alternatively, just use the metal bracket supplied, however, ensure the fan is supported adequately.
4. Attach the ducting to the lip at either end of the fan. If using flexible ducting, fit the ducting over each lip and secure it with worm drive clips. If using rigid ducting, butt the ducting up to each end of the fan and hold it in place with solid duct fasteners.

Wiring the fan

1. Make sure the mains supply is isolated
2. Unscrew the terminal box cover and remove it.
3. Slide the mains cable through the cord grip a short distance, but enough to make the terminations.
4. Connect the wires to the terminal blocks as shown in **C** ensuring the blocks are positioned over the locating pins **D1**.
5. Tighten the screw in the cord grip to secure the cable.
6. If installing the fan with a controller, refer to the wiring instructions supplied with the controller.
7. Place the capacitor over the top of the terminal blocks **D2**.
8. Replace the terminal box cover and fasten the retaining screws, ensuring the cover is completely sealed over the terminal box, enclosing all the wires, but not trapping any.
9. Reconnect the electrical supply.

Operating the fan

To turn the fan on or off, use the double pole isolating switch. If the fan is installed with a speed controller, refer to the instructions supplied with the controller.

Looking after the fan

Xidpel offer full maintenance and service facilities to cover all requirements. Please contact Technical Services.

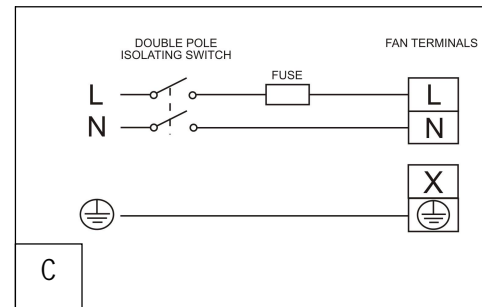
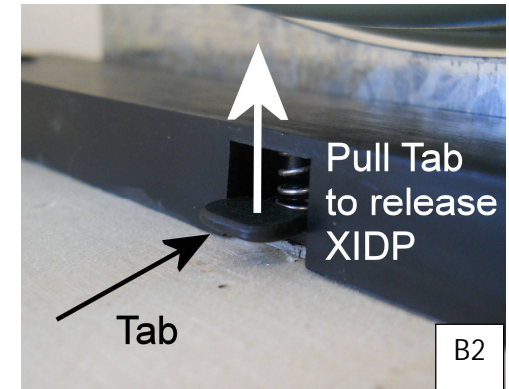
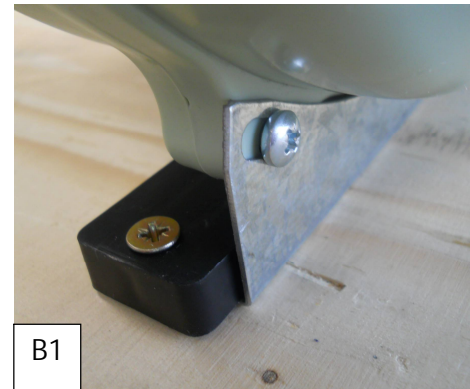
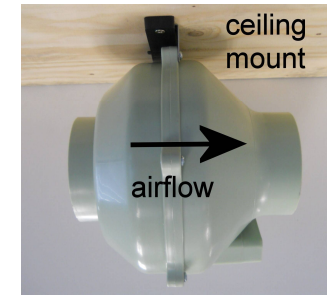
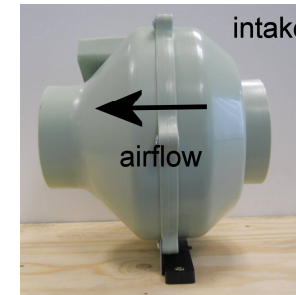
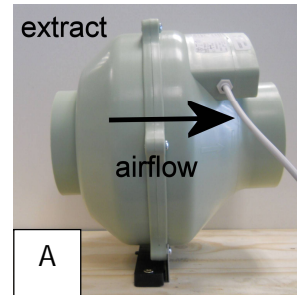

Model	øA mm	øB mm	C mm	D mm	Weight Kg
XIDP100	99	288	30	247	2.0
XIDP125	124	288	30	247	2.1
XIDP150	149	379	30	230	2.5
XIDP200	199	379	30	230	3.8
XIDP250	249	379	30	230	4.3
XIDP315	314	452	30	275	5.5