

CDimplex



BIZET

EN : This product is only suitable for well insulated rooms or occasional use. DE : Dieses Produkt ist nur für gut isolierte Bereiche oder gelegentliche Verwendung geeignet. FR : Ce produit convient uniquement à des endroits bien isolés ou pour un usage occasionnel. IT : Questo prodotto è adatto solo per spazi ben isolati o per uso occasionale. ES : Este producto sólo es adecuado para espacios bien aislados o un uso ocasional. NL : Dit product is uitsluitend geschikt voor goed geïsoleerde ruimten of voor sporadisch gebruik. PL : Produkt ten jest odpowiedni wyłącznie do dobrze odizolowanych miejsc lub do okazjonalnego użytku. NO : Dette produktet egner seg kun for godt isolerte rom eller sporadisk bruk. RO : Acest produs este adecvat exclusiv spațiilor bine ventilate sau utilizării ocazionale. CZ : Tento výrobek je vhodný pouze do dobře izolovaných prostor nebo k příležitostnému použití. DK : Dette produkt er kun egnet til velisolerede rum eller lejlighedsvis brug. PT : Este produto somente é adequado para espaços bem isolados ou uso ocasional. SE : Denna produkt är endast avsedd för välisolerade utrymmen eller tillfällig användning. FI : Tämä tuote soveltuu ainoastaan hyvin eristettyihin tiloihin tai satunnaiseen käyttöön. SK : Tento výrobok je vhodný len pre dobre izolované priestory alebo na občasné použitie. SI : Ta izdelek je primeren le za dobro izolirane prostore ali za občasno uporabo. HR : Ovaj proizvod je pogodan samo za dobro izolirane prostore ili povremenu upotrebu. HU : Ez a termék csak jól szigetelt terekhez vagy eseti használatra alkalmas. SV : Denna produkt är endast lämplig för användning i väl isolerade utrymmen eller enstaka användning.



The product complies with the required Product Safety, Electromagnetic Compatibility and Environmental Standards.
This product is fully compliant with LVD, EMC, RoHS and EcoDesign Directives.

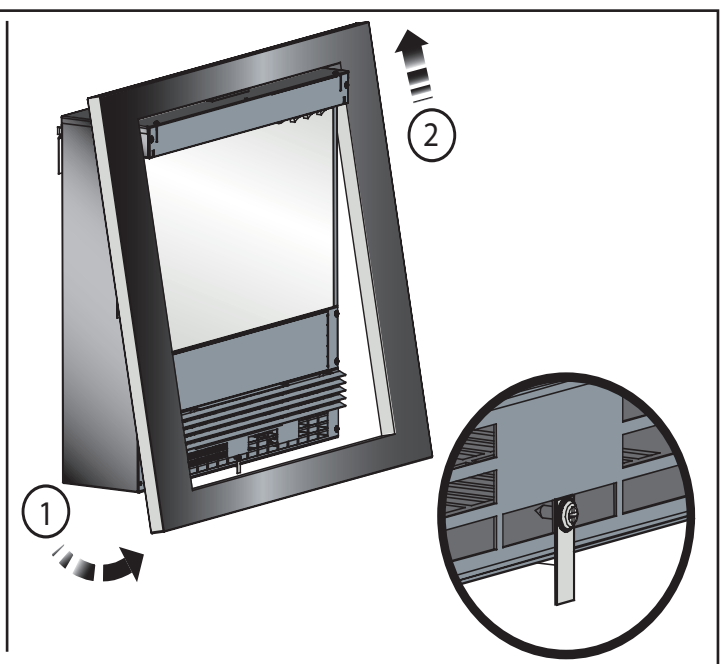
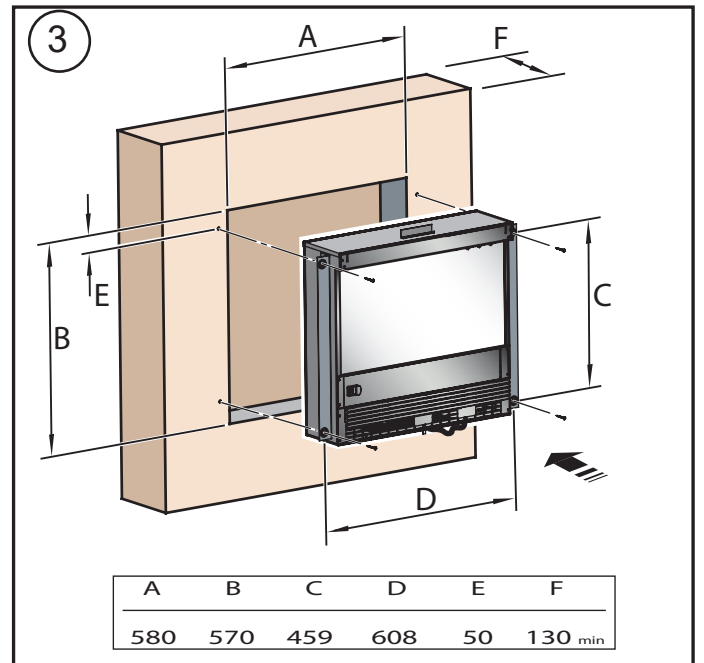
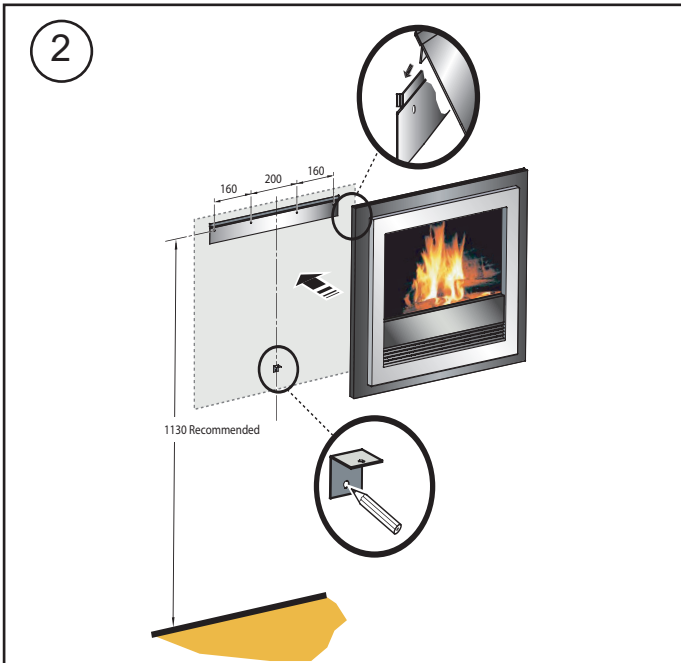
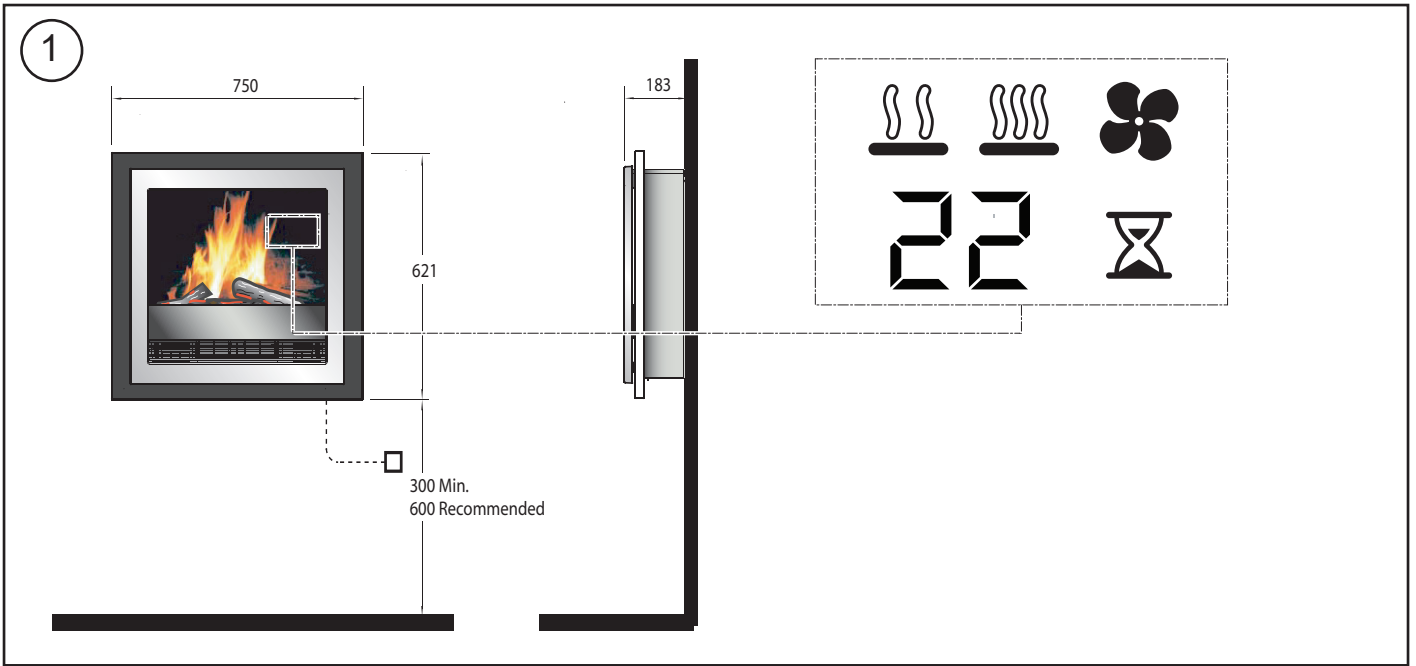

5

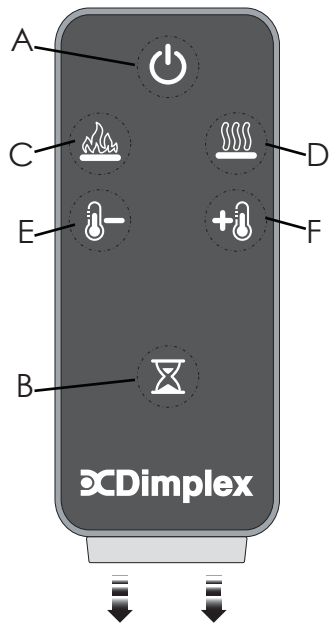
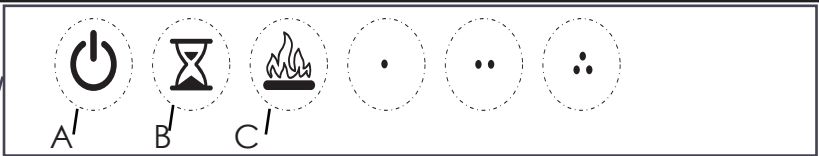

Important Safety Advice

When using electrical appliances, basic precautions should be followed to reduce the risk of fire, electric shock, and injury to persons, including the following:

If the appliance is damaged, check immediately with the supplier before installation and operation.

Do not use this appliance in the immediate surroundings of a bath, shower or swimming pool.

Do not use outdoors.

This appliance must not be located immediately above or below a fixed socket outlet or connection box.

⚠ WARNING: The appliance carries the Warning Symbol indicating that it must not be covered or has a Do not cover label. Do not cover or obstruct in any way the heat outlet grille located below the flame window on the appliance. Overheating will result if the appliance is accidentally covered. Do not place material or garments on the appliance, or obstruct the air circulation around the appliance, for instance by curtains or furniture, as this could cause overheating and a fire risk.

In the event of a fault unplug the heater. Unplug the appliance when not required for long periods. The supply cord must be placed on the right hand side of the heater away from the heat outlet underneath the appliance.

This appliance can be used by children aged from 8 years and above and persons with reduced physical, sensory or mental capabilities or lack of experience and knowledge if they have been given supervision or instruction concerning use of the appliance in a safe way and understand the hazards involved. Children shall not play with the appliance. Cleaning and user maintenance shall not be made by Children without supervision. Children of less than 3 years should be kept away unless continuously supervised. Children aged from 3 years and less than 8 years shall only switch on/off the appliance provided that it has been placed or installed in its intended normal operating position and they have been given supervision or instruction concerning use of the appliance in a safe way and understanding the hazards involved. Children aged from 3 years and less than 8 years shall not plug in, regulate and clean the appliance or perform user maintenance.

The appliance must be positioned so that the plug is accessible.

Although this appliance complies with safety standards, we do not recommend its use on deep pile carpets or on long hair type of rugs.

If the supply cord is damaged it must be replaced by the manufacturer or service agent or similarly qualified person in order to avoid a hazard.

CAUTION: In order to avoid a hazard due to inadvertent resetting of the thermal cut-out, this appliance must not be supplied through an external switching device, such as a timer, or connected to a circuit that is regularly switched on and off by the utility.

CAUTION - Some parts of this product can become very hot and cause burns. Particular attention has to be given where children and vulnerable people are present.

Technical Information

Model No: ASPIRE FSC E, ENCHANT E, BCH20E, BZT20E, BACH-E

Heat Output 230V 240V

Nominal Heat Output	P_{Nom}	1.7	-	1.9	kW
---------------------	-----------	-----	---	-----	----

Minimum Heat Output	P_{min}	0.9	-	1.0	kW
---------------------	-----------	-----	---	-----	----

Maximum Continuous Heat Output	$P_{max,c}$	1.7	-	1.9	kW
--------------------------------	-------------	-----	---	-----	----

Auxiliary Electricity Consumption

In Standby mode	eI_{SB}	0.41	-	0.44	W
-----------------	-----------	------	---	------	---

with electronic room temperature control

General

Unpack the heater carefully and retain the packaging for possible future use, in the event of moving or returning the fire to your supplier.

The fire incorporates a flame effect, which can be used with or without heating, so that the comforting effect may be enjoyed at any time of the year. Using the flame effect on its own only requires little electricity.

Before connecting the heater check that the supply voltage is the same as that stated on the heater.

Please note: Used in an environment where background noise is very low, it may be possible to hear a sound which is related to the operation of the flame effect. This is normal and should not be a cause for concern.











Electrical Connection

⚠ WARNING: THIS APPLIANCE MUST BE EARTHED

This heater must be used on an AC ~ supply only and the voltage marked on the heater must correspond to the supply voltage.

Before switching on, please read the safety warnings and operating instructions.

Controls: See Fig. 5

	Icon	Display	Function	Description
A		-	Power / Standby	Press Once to turn the product 'ON'. Press a second time to put the product into 'STANDBY' (When returning from 'STANDBY' mode the product will return to previous settings unless the product has been plugged out, in which case it will reset to factory settings)
B			Sleep Timer	Press multiple times to change the 'SLEEP TIMER' in 0.5 hr increments from 0.5 hr to 8.0 hr before turning off. The remaining time on the 'SLEEP TIMER' displays. (This icon is Green in Colour)
C		Flame Effect		'FLAME EFFECT' button cycles the unit sequentially through the 4 setting, LOW FLAME, HIGH FLAME, DEMO MODE and OFF.
		F1	Low Flame	This setting will run the flame effect at a low brightness level. (The display will show F1)
		F2	High Flame	This setting will run the flame effect at a high brightness level. (The display will show F2)
		FP	Demo Mode	This setting will slowly pulse the flame effect between low and high brightness. (The display will show FP)
		-	Off	This will turn the flame effect off. If the heater is running, the display will activate and remain active to read the set temperature and show if the product is on LOW HEAT/ HIGH HEAT/COOL BLOW.
D		Heat		'HEAT' button cycles the unit sequentially through the 4 settings: LOW HEAT, HIGH HEAT, COOL BLOW and OFF. The heat setting will be indicated by an icon in the floating display see Fig.1. When the flame effect is 'ON' the floating display will turn off after 5 seconds, however if the heater is being used independantly of the flame effect. The low heat or high heat icon will appear continuously in the floating display.
			Low Heat	This setting will run the heater at 'LOW HEAT' this setting will be indicated by the 'LOW HEAT' icon and the letters 'LO' appearing in the display. (This icon is Orange in Colour)
			High Heat	This icon in the floating display indicates 'HIGH HEAT' this setting will be indicated by the 'HIGH HEAT' icon and the letters 'HI' appearing in the display. (This icon is Red in Colour)
			Cool Blow	This icon in the floating display indicates 'COOL BLOW' this setting will be indicated by the 'COOL BLOW' icon and the letters 'CB' appearing in the display. (This icon is Blue in Colour)
		-	Off	This switches the heater and blower 'OFF', no icon will be displayed in the floating display. Note the blower will run for 10-20 seconds after being turned off this is to ensure the product cools down safely.
E		-	Temp Down	Press multiple times to lower the heater temperature in 1°C increments. The lowest temperature that can be set 5°C. Note: Once you stop at your desired temperature this will flash 3 times, then the display will show the room temperature as detected by the product. If the set temperature is lower than the detected room temperature the heater will not activate.
F		-	Temp Up	Press multiple times to increase the heater temperature in 1°C increments. The highest temperature that can be set 37°C. Note: Once you stop at your desired temperature this will flash 3 times, then the display will show the room temperature as detected by the product. If the set temperature is lower than the detected room temperature the heater will not activate.

User Modes:

Mode Name /Discription	Action (Actions cannot be input by remote control)
Change Celsius (° C) to Fahrenheit (° F)	Press both 3 Dot Button (•••) and 2 Dot (••) on the unit and hold until beep is heard and display flashes. (To revert back to Celsius repeat this action)
Disable/Enable Heat Options	Hold both 1 Dot Button (•) and Flame Button (), on the unit, for 2 seconds, when the heater has been disabled the display will read "--" and beep. To enable heat repeat this action.

Remote Control - See Fig. 6

The maximum range of use is ~ 5metres.

NOTE: It takes time for the receiver to respond to the transmitter.

NOTE: The receiver for the remote control is located in the display, aim the remote control in this direction when inputting commands.

Do not press the buttons more than once within two seconds for correct operation.

Battery Information - See Fig. 6

1. To activate the remote control remove the clear battery isolation strip at the base of the remote control, which is used to ensure your remote control reaches you fully charged.

2. To replace the remote control battery, turn over the remote control, and follow the diagram embossed on the remote control

3. Only use CR2025 or CR2032 size of batteries.

Wall fixing - see Fig. 2, 3 & 4

The appliance should be securely fixed to the wall using the wall plugs and screws supplied for block walls.

Note – for studded walls special fasteners are required, see diagram for recommended position of fixing screws.

Recessed Installation

Please note that this appliance can also be wall-mounted so that it is recessed. This can be installed in a large fireplace opening or a purpose built wall. See **Fig. 3** for size of recess required and hole fixing dimensions. This fireplace insert does NOT require venting.

In order to ensure it's future safety in use, it is essential that this fire is securely fixed to the wall.

IT IS IMPORTANT THAT THE FIXING DEVICE CHOSEN IS APPROPRIATE TO THE WALL MATERIAL TO WHICH THE FIRE IS BEING FIXED. SOME MODERN INTERNAL BUILDING MATERIALS ARE VERY LOW DENSITY BLOCK AND REQUIRE SPECIALIZED FIXING DEVICES TO PROVIDE A SAFE, SECURE INSTALLATION.

The installation of this fire should be carried out by a competent person. If in doubt please consult your local builder.

This section provides step by step instructions for selecting a location and preparing the site to install the fireplace into the following:

Existing Fireplace

1. Make sure that the fire is located on a flat surface.
2. Seal all draughts and vents to prevent chimney debris from falling onto the Fireplace Insert. Do not install into an existing fireplace that is prone to dampness.
3. Remove the front/trim by following the steps as outlined in **Fig. 4**
4. Locate the 4 fixing holes, position the fire accordingly, and firmly fix the appliance to the wall using the appropriate screws.
5. Replace the front/trim.

New Support Structure Construction

When planning where to position your purpose built support structure the following steps must be observed:

1. Place the fire in the desired location to see how it will look in the room.
2. Mark the desired location for the new support structure in the room and store the fire in a safe, dry and dust free location.

3. Using timber studs to support the fire, devise and construct a suitable means of supporting the product within the wall partition and provide electrical power for the fire to be HARD wired. For recommended sizes of height, width and depth of opening for recess and hole fixing dimensions for each model - see **Fig. 3**.

4. Remove the front/trim by following the steps as outlined previously.

5. Locate the 4 fixing holes, position the fire accordingly, and firmly fix using the appropriate screws.

6. Replace the front/trim.

NOTE: The appliance should be HARD wired to an electrical power outlet when placed in a recessed installation.

Please consult a qualified electrician for appropriate wiring requirements.

Trim colour options – see Fig. 4

NOTE: Trim Colour Options only available on Bizet & Aspire.

The fire comes with a reversible inner trim. To reverse the trim first remove the front cover as per Fig.3, gripping the front panel on either side, gently pull the bottom of the panel forward while lightly lifting upward, the front panel should lift away.

This will allow access to the reversible trim, once again gripping the trim on either side gently pull the bottom of the trim forward while lightly lifting upward, the reversible trim will lift away.

Now carefully replace the panels in the reverse of above.

Thermal Safety Cut-out

The built-in overheat cut-out, switches off the appliance automatically in the event of a fault! Should this occur switch off the appliance or disconnect the mains plug from the socket.

Remove any obstructions which may have caused the overheating. After a short cooling down phase, the appliance is ready for use again! If the fault should occur again, contact your local dealer!

WARNING: In order to avoid a hazard due to inadvertent resetting of the thermal cut-out, this appliance must not be supplied through an external switching device, such as a timer, or connected to a circuit that is regularly switched on and off by the utility.

Maintenance

⚠ WARNING: ALWAYS DISCONNECT FROM THE POWER SUPPLY BEFORE ATTEMPTING ANY MAINTENANCE.

Light Emitting Diode

This fire is fitted with LED (Light Emitting Diode) lamps. These LED lamps are maintenance-free and should not require replacing during the life of the product.

Cleaning

⚠ WARNING: ALWAYS DISCONNECT FROM THE POWER SUPPLY BEFORE CLEANING THE HEATER.

For general cleaning use a soft clean duster – never use abrasive cleaners. The glass viewing screen should be cleaned carefully with a soft cloth.

DO NOT use proprietary glass cleaners.

To remove any accumulation of dust or fluff the soft brush attachment of a vacuum cleaner should occasionally be used to clean the outlet grille of the fan heater.

WARNING: do not operate the product without the grille and outer glass in position as this may effect the operation of the heater.

Recycling

At the end of the electrical products useful life it should not be disposed of with household waste. Please recycle where facilities exist. Check with your Local Authority or retailer for recycling advice in your country.



After Sales Service

Your product is guaranteed for one year from the date of purchase.

Within this period, we undertake to repair or exchange this product free of charge (excluding lamps & subject to availability) provided it has been installed and operated in accordance with these instructions.

Your rights under this guarantee are additional to your statutory rights, which in turn are not affected by this guarantee.

Should you require after sales information or assistance with this product please go to www.dimplex.co.uk where you will find our self help guide by clicking on "After Sales" or ring our helpdesk on 0344 879 3588 (UK) or 01 842 4833 (R.O.I.) .

Spare parts are also available on the website www.dimplex.co.uk

Please retain your receipt as proof of purchase.

Dimplex
Millbrook House
Grange Drive
Hedge End
Southampton