

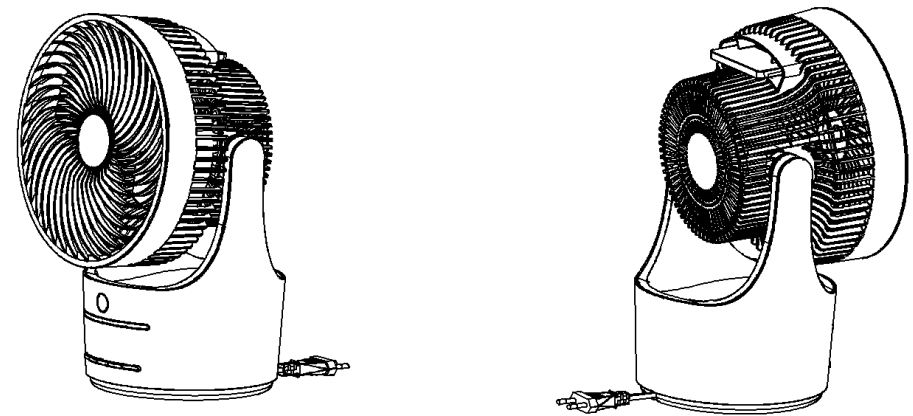

USE & CARE INSTRUCTIONS



Circulation Fan Model XPA360CF

**PLEASE READ THESE INSTRUCTIONS CAREFULLY
AND SAVE FOR FUTURE REFERENCE**

A division of Glen Dimplex UK Ltd.

Website: www.dimplex.co.uk

This product complies with all the required European and UK Product Safety, Electromagnetic Compatibility and Environmental Standards. They are fully compliant with with the LVD, EMC, RoHS and Eco Design Directives and Regulations.

© Glen Dimplex UK Ltd.

All rights reserved. Material contained in this publication may not be reproduced in whole or in part without prior permission in writing of Glen Dimplex.

08/53765/0 Issue 4



IMPORTANT WARNINGS

Failure to comply with the warnings listed below may result in electric shock or serious injury.

This product should be used only in accordance with the specifications outlined in this manual. Usage other than as specified in these instructions may result in serious injury, risk of fire or electric shock.

- **IMPORTANT** - To reduce the risk of electric shock, the plug is intended to fit in a standard polarized 13Amp socket outlet, only plug the appliance directly into a proper electrical outlet.
- To protect against electrical hazards, **DO NOT** immerse in water or other liquids. Do not use near water.
- Children cannot recognize the hazards associated with the usage of electrical appliances. For this reason, always supervise children when they are near the unit. This appliance can only be used by children aged from 8 and above and persons with reduced physical, sensory or mental capabilities or lack of experience and knowledge if they have been given supervision or instruction concerning use of the appliance in a safe way and understand the hazards involved. Children shall not play with the appliance. Cleaning and user maintenance shall not be made by children without supervision.
- Children aged from 3 years and less than 8 years shall only switch on/off the appliance if it has been placed or installed in its intended normal operating position and they have been given supervision or instruction concerning use of the appliance in a safe way and understand the hazards involved. Children aged from 3 years and less than 8 years shall not plug in, regulate and clean the appliance or perform user maintenance.
- Always unplug the fan before moving, cleaning or whenever the fan is not in use. Be sure to pull by the plug and not the cord when un-plugging the appliance.
- **NEVER** drop or insert any object into any openings.
- **DO NOT** operate appliance connected to an extension cable
- Keep the cord out of heavy traffic areas. To avoid fire hazard, **NEVER** put the cord near heat registers, radiator, stoves or heaters.
- **DO NOT** cover cord with carpeting, throw rugs, runners, or similar coverings.
- **DO NOT** route cord under furniture or appliances. Take care to position the cord away from traffic areas and where it will not be a trip hazard.

- **DO NOT** operate any appliance with a damaged cord or plug, if motor fan fails to rotate, after the appliance malfunctions, or if it has been dropped or damaged in any manner. Please contact our Customer Service team for assistance.
- Use appliance only for intended household use as described in this manual. Any other use not recommended by the manufacturer may cause fire, electric shock or injury to persons.
- **DO NOT** use outdoors. **DO NOT** place anything on top of the appliance.
- **NEVER** block the air openings, grills/outlets or place on a soft surface such as a bed or sofa, as this could cause the unit to tip over, blocking the air intake or outtake opening.
- **DO NOT** attempt to repair or adjust any electrical or mechanical functions on this unit. Doing so will void your warranty. The inside of the unit contains no user serviceable parts.
- **WARNING:** To reduce the risk of fire or electric shock, do not use this fan with any solid-state speed control device.
- **WARNING:** To avoid danger of suffocation please remove all packaging materials particularly plastic and EPS and keep these away from vulnerable people, children and babies.
- **WARNING:** To avoid the risk of accidental strangulation from the supply cord all children and vulnerable people must be supervised when near the product whether it is working or not.
- **WARNING:** Keep batteries out of reach of children, dispose of used button batteries immediately and safely.

PRODUCT FEATURES

- 1) On Board Electric touch control buttons;
- 2) Handy Infrared Remote control with storage slot on product;
- 3) 3 Selectable Fan speeds: High, Medium, Low;
- 4) 3 blowing modes: Normal, Natural, Sleeping
- 5) Runback Timer Function: 1H、 2H、 4H、 8H;
- 6) Oscillation: Wide selection of horizontal oscillation angles can be selected: - 30°, 90°, 180° and 360° are available
- 7) Blower head can be adjusted and set manually with a 90° vertical rotation possible;

PART DIAGRAMS

● Product structure

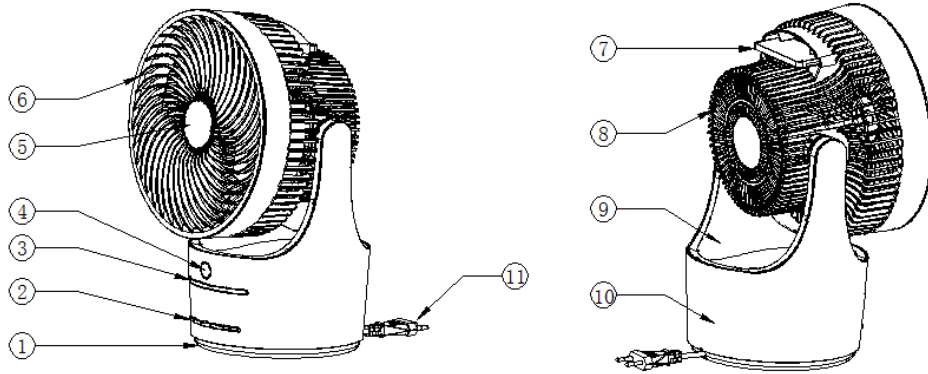

- | | | |
|------------------------|---------------------|---------------------------------|
| 1. Base | 2. Control Buttons | 3. LED indicator lights |
| 4. IR Receiving window | 5. Decorative Cover | 6. Fan guard |
| 7. Remote Controller | 8. Rear housing | 9. Vertical Oscillation Support |
| 10. Fan Body | 11. Power cord | |

● Control Button panel

(See Operating Instructions section for details of symbols)

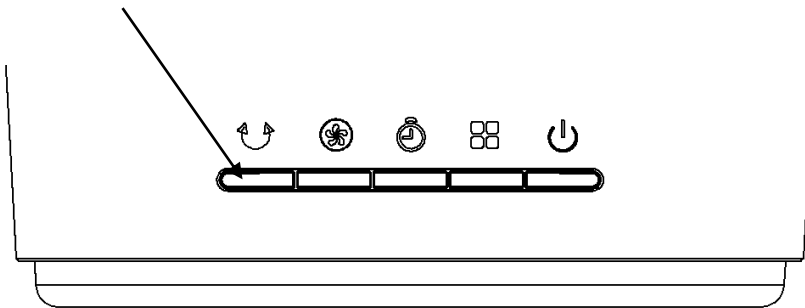

● Remote Control



● LED indicator light display panel & IR remote signal receiving window

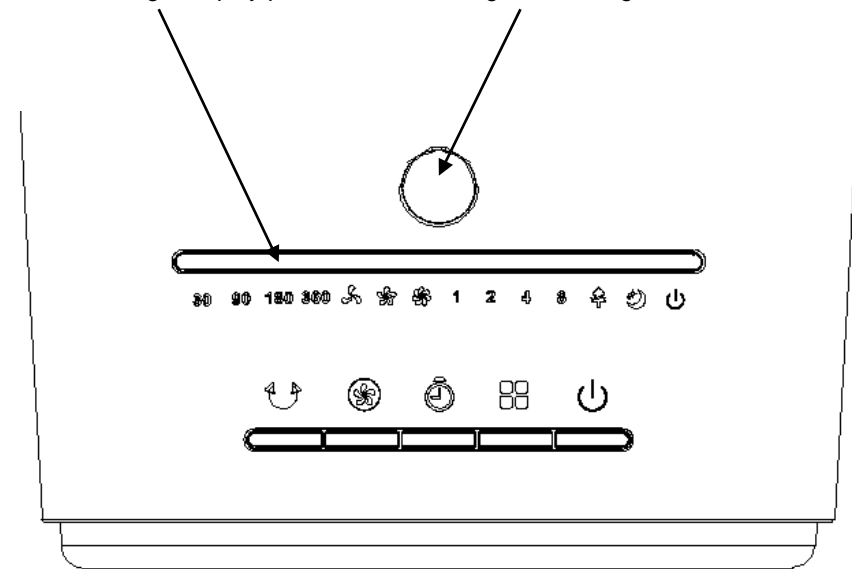

INSTALLATION INSTRUCTION

- Installation Methods

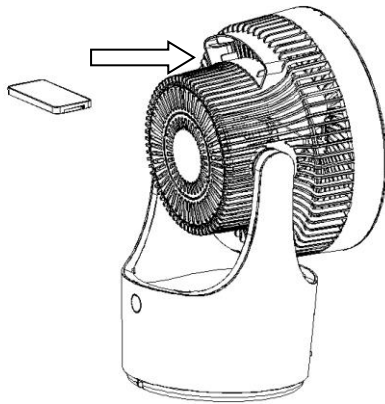

1. Open up the carton and take out the product, Instruction and the remote control, store or dispose of the packaging materials carefully.
2. This product does not require assembly, it is ready to operate once all packaging materials are removed. The handle in the rear housing should be used to lift and carry the product, it can also be used to store the remote control when not in use. (See figure 1)





(Figure 1)

OPERATING INSTRUCTIONS:

Unwrap the cable and plug in the product, it will beep twice to signify that it is connected and remain in standby mode, note that there are no LED indications in this mode.

1) Power Button - : You must always press this button to start the product, every time you start the product it will always default to operate in Normal mode at Low speed with the low speed LED and the power on LED both illuminated, no other function will operate unless the relevant selection button is pressed (see following details). Pressing the power button  again during any mode of operation will return the product to standby mode.

2) Blower Mode Selection Button - : The default operating mode when you power on is Normal air blower mode, there is no separate Normal blower mode operating LED. Pressing  when operating will change the blower operation modes from Normal to Natural mode,

Natural to Sleep mode and Sleep back to Normal mode, the relevant LED light will indicate when Natural and Sleep mode is selected, only the selected fan speed LED will light in Normal Blower mode.

Normal Blower mode: You can simply use the fan speed selection button  to manually select Low, Medium or High speed fan operation, the relevant speed indication LED will light as you change between speeds in sequence.

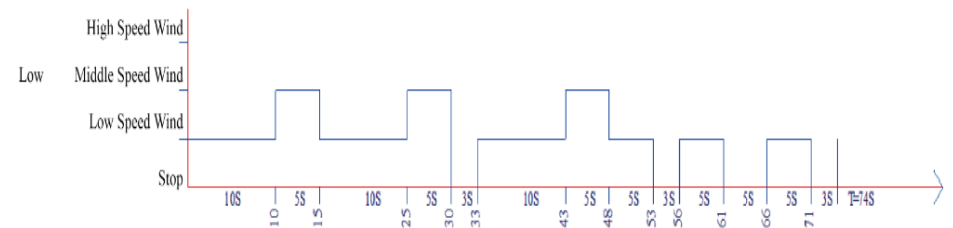
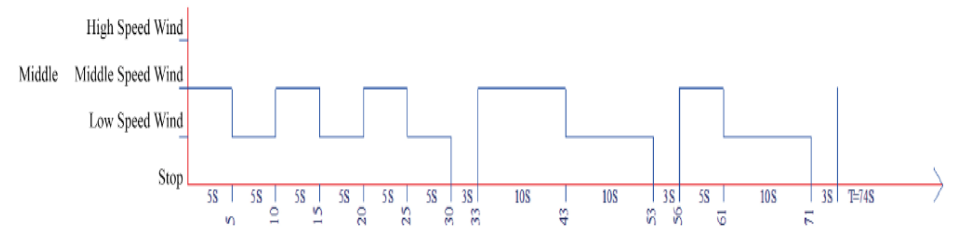
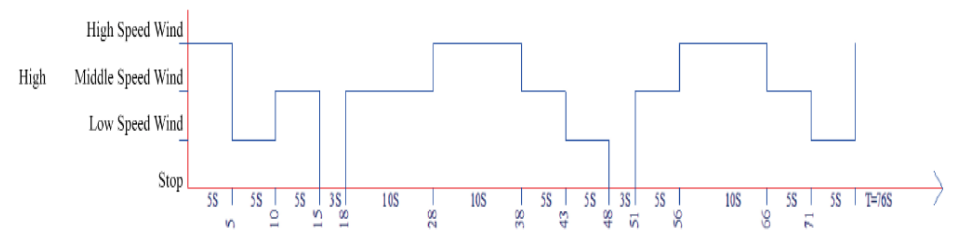

Natural Blower mode: In this mode the fan will automatically change speed to simulate natural variances in the speed of the wind that you experience outside in natural windy conditions. In this mode you can use the speed selection button to change between Low/'Light breeze', Middle/'Strong Breeze' and High/'Strong Wind' modes. The specific program waveform graph for each Natural wind mode is shown below:



Sleep mode: In this mode the fan speed will continuously vary speed to prevent users from getting sick when asleep. You can select 3 different running patterns in this mode by using the Speed Selection button, the patterns of operation in each speed mode are as follows;

- High speed: Varies between High speed in Normal Blower mode→ Medium speed in Natural Blower mode→ Low speed in Natural Blower mode:
- Medium speed: Varies between Medium speed in Natural Blower mode →Low speed in Natural Blower mode
- Low speed: Operates at Low speed in Natural Blower mode.

3).Runback Timer Mode Button- : By pressing this button, the fan can be set to operate continuously in your selected mode of operation for different time intervals, you can select 1 hour, 2 hours, 4 hours or 8 hours, the selected period will be indicated by its LED light which will remain on for the selected period, when the selected operating time has run out the product will switch off automatically and go into standby mode until the user needs it again.





4) Fan Speed Selection Button - : When you start the product it will always default to operate in Normal mode at Low speed with the low speed LED and the power on LED illuminated. Pressing the  button allows you to change from Low to Medium, Medium to High and High back to Low fan speed , the relevant LED light will illuminate to indicate which fan speed is selected/operating.

5) Oscillating Mode Selection Button- : By pressing this button while the product is operating you can select between different angles of oscillation for the product, the product can be set to oscillate at an angle of 30°, 90°, 180° or 360°, the angle selected will be indicated by the illumination of the relevant LED. You have to move through all the oscillation selection options to return to oscillation off mode (when no oscillation LED will be lit).

Note that the oscillation is controlled by what's called a stepping motor, this means it will swing first to the right and then to the left from the starting point over half the swing angle selected, this applies to all angles apart from the 360° selection, in this setting it will swing clockwise continuously around completing 360° each time it rotates

6) Please Note

In any mode of operation you can use the power button to switch the product off/into standby mode at any time, when you next press the power button to switch the product back on it will remember the last wind speed and oscillation settings and switch back on at these in Normal Blower Mode, it will not remember if the product was in a Runback Timer mode or in a different Blower Mode setting.

NB - If the fan speed varies randomly automatically you have selected NATURAL  **mode which simulates natural breeze conditions. THIS IS NOT A FAULT. To de-select this operation please press the MODE button**  **until a NORMAL mode speed symbol**  **is lit and only use the SPEED selection button**  **to change and select the fan speed you require (Low / Med / High).**

NB – When the product is left running without switch/control operation for 1 minute the LED indicator light display will switch off automatically, this is to avoid user disturbance or distraction by the light (particularly if used at night), The lights will switch on again when the user activates any control button (except the off button), the product can then be operated normally as described above, if the 'off' button is activated the product will just switch off and the lights will not re-energise.

7) Remote Control Use:

- To activate the remote control release and slide out the battery holder from the bottom back of the remote control handset (as indicated below), install your 3V CR2032 button battery cell into its location ensuring the positive and negative pole are as indicated on the label on the back of the remote and reinstall the battery holder completely. Align to infrared receiver module when using remote controller.

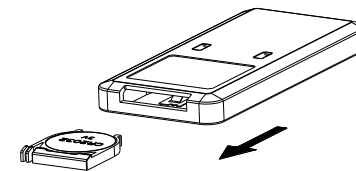

- Remote Control will only operate the product if it is in direct line of site and within a distance of 6 meters from the product. If it fails to do so under these conditions after the product has been in use for some time please check the battery is not depleted before taking any other action.

TECHNICAL SPECIFICATION

Model	XPA360CF
Rated Voltage	AC220V-240V
Rated Frequency	50Hz
Rated Wattage	45W
Noise Level	≤55dB (Average sound pressure level)
Size	240x203.5x340mm
Standards application	EN 60335-1; EN 60335-2-80

CLEANING AND MAINTENANCE

Note: If there is too much dust or dirt on the air outlet / inlet grill and the blower wheel of the product then the performance will be affected, if being used regularly we recommend that you clean the product at least once a month.

IMPORTANT

- Always remember to unplug the product before cleaning or maintenance because of the risk of electric shock.

- Do not allow water, steam or any other fluid to enter the appliance.

- Do not use abrasive cleaning products as they will damage the product surfaces.

You can use a vacuum cleaner to remove loose dust and particulate matter.

Clean surfaces using a soft damp cloth or a soft banister brush.

Do not use any Chemical cleaning agents, corrosive detergents or solvent cleaners.

Unplug and pack the product away carefully to prevent dust from entering the product when not in use for a long time.

Store in a dry and well-ventilated space when not in use to prevent moisture ingress which might cause the product to malfunction or fail.



RECYCLING

The crossed bin symbol on the appliance indicates that the product, at the end of its life, must be disposed of separately from domestic waste, either by taking it to a separate waste disposal site for electric and electronic appliances or by returning it to your dealer when you buy another similar appliance. The user is responsible for taking the appliance to a special waste disposal site at the end of its life. If the disused appliance is collected correctly as separate waste, it can be recycled, treated and disposed of ecologically; this avoids a negative impact on both the environment and health, and contributes towards the recycling of the product's materials. For further information regarding the waste disposal services available, contact your local waste disposal agency or manufacturer.

After Sales Service and Guarantee terms and conditions

Your product is guaranteed for 1 year from the date of purchase. If you experience a problem with our Xpelair product, which is found to be defective due to faulty materials or workmanship within the Guarantee Period, this Xpelair Guarantee will cover repair or - at the discretion of Xpelair- replacement with a functionally equivalent Xpelair product.

Within the guarantee period we undertake to repair or exchange this product free of charge providing:

- a) Proof of purchase such as a sales receipt should be provided, showing that the appliance was bought within the 12-months prior to registering the defect/fault.
- b) The appliance was correctly installed and operated in accordance with the manufacturer's instructions and used solely for domestic purposes.
- c) The defect/fault was not as a result of accident, misuse, unauthorised modification or inexpert repair

Your rights under this guarantee are additional to your statutory rights, which in turn are not affected by this guarantee.

If after following these steps your product still does not operate you should return it to your point of purchase. Please do not return a faulty product to us as this may result in loss or damage and delay in providing you with a satisfactory service. Please retain your receipt as proof of purchase.

What is not covered by an Xpelair Guarantee?

The Xpelair Guarantee does not cover any of the following:

Any fault or damage to your Xpelair product due to faulty materials or workmanship occurring outside the one year Guarantee Period.

Normal wear and tear including parts that might wear out over time or consumables, such as filters.

Any fault or damage occurring to any pre-owned Xpelair product or to any other equipment or property.

Accidental damage to your Xpelair product or damage to your Xpelair product from external sources (for example, transit, weather, electrical outages or power surges).

Fault or damage to your Xpelair product which is:

- not due to faulty materials or workmanship or which is due to circumstances outside Xpelair's control.
- caused by use of your Xpelair product for anything other than normal domestic household purposes in the country where it was purchased.
- caused by any misuse, abuse or negligent use of the Xpelair product, including but not limited to any failure to use it in accordance with the Operating Instructions supplied with the product.
- caused by any failure to assemble, install clean and maintain your Xpelair product in accordance with the Operating Instructions supplied with the product unless this was carried out by Xpelair or its authorised dealers.
- caused by repairs or alterations to your Xpelair product not carried out by Xpelair service personnel or its authorised dealer(s).
- caused by use of any consumables or spare parts for your Xpelair product which are not Xpelair specified. A full range of Xpelair specified consumables, parts and accessories is available at www.xpelair.co.uk

Terms and Conditions

The Xpelair Guarantee is valid for one calendar year from the date of purchase of your Xpelair product from a recognised retailer in the country of purchase and use, or the date of delivery of the product if later, always provided the original receipt has been retained and is produced as proof of purchase.

You must provide to Xpelair or its authorised agents on request the original receipt as proof of purchase and - if required by Xpelair - proof of delivery. If you are unable to provide this documentation, you will be required to pay for any repair work required.

Any repair work under the Xpelair Guarantee will be carried out by Xpelair or its authorised dealer(s) and any parts that are replaced will become the property of Xpelair. Any repairs performed under the Xpelair Guarantee will not extend the Guarantee Period.

Any replacement of your Xpelair product by Xpelair during the Guarantee Period will start the one-year Guarantee Period afresh from the date of delivery of the replacement Xpelair product to you.

The Xpelair Guarantee does not entitle you to recovery of any indirect or consequential loss or damage including but not limited to loss or damage to any other property.

The Xpelair Guarantee is in addition to your statutory rights as a consumer and your statutory rights are not affected by this Xpelair Guarantee.

Contact Xpelair A brand of Glen Dimplex UK Limited, trading as Glen Dimplex Heating & Ventilation

If you have any questions about what the Xpelair Guarantee covers and does not cover or how to claim under the Xpelair Guarantee, please contact us:

Glen Dimplex UK Ltd., Millbrook House, Grange Drive, Hedge End, Southampton SO30 2DF

Telephone: 0344 879 3588

Visit: www.dimplex.co.uk